

Features

- 12 voltage inputs
- 16-bit, 100-kHz per channel sample rate
- $\pm 10V$ input range
- Eight digital I/O
- Simultaneous sampling
- BNC connectors
- Multiple trigger modes
- Compact, portable design
- Expandable using multiple 6000 Series modules

Software

- Includes Encore interactive measurement software for *Out-of-the-Box* setup, acquisition, display, logging, analysis, and reporting
- Advanced feature set with no programming required
- Drag-and-drop functionality
- Easy-to-use set-up wizards
- Ability to drag data directly to Excel®
- Included data analysis tools
- Playback mode
- Sophisticated test report capability
- Incorporate multiple 6000 Series devices into one application
- Supported Operating Systems: Windows 2000®, Windows Vista® x86 (32-bit), and Windows XP® (32-bit)

Overview

The 6000 Series combines accurate, instrument class, Ethernet-based modules with powerful, easy-to-use software. It is a major advancement in ease of use and functionality. 6000 Series modules feature integrated signal conditioning and a modular design that allows for system expansion. Because they use an Ethernet connection, modules can be connected directly to a PC or used in remote configurations utilizing multiple modules.

Each 6000 Series module includes Encore interactive measurement software. Encore couples ease-of-use with advanced functionality including custom data displays, powerful analysis, and detailed reporting capabilities.



The 6220 with Encore software is a portable, voltage measurement solution

6000 Series Modules		
Feature	6220	6224
Analog inputs	12	12
Digital I/O	8	8
Resolution	16-bit	24-bit
Sample rate	100-kHz per channel	50-kHz per channel
Analog input type	voltage	strain gage/bridge

Analog Inputs

The 6220 is equipped with 12 analog input channels with a $\pm 10V$ range. Each analog input provides 16-bit resolution with a maximum 100-kHz per channel sample rate. All channels are sampled simultaneously.

Digital I/O

The 6220 includes eight digital I/O lines. All eight lines are accessible via a 9-pin female DSUB connector located on the rear panel of the unit. Each digital I/O bit can be programmed individually to be either an input or an output.

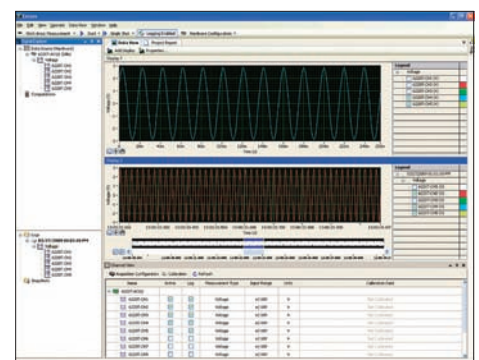

Encore provides real-time viewing and analysis of data along with built-in test report capabilities

6220

General Information

6220 System Examples

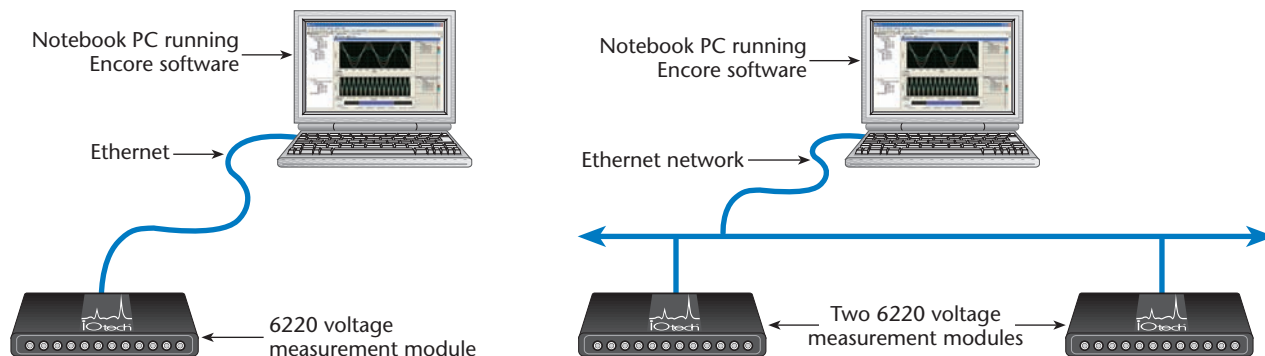

Triggering

A variety of trigger modes are supported by the 6220. A wide selection of programmable analog and digital trigger modes are available for starting an acquisition. All trigger modes, along with the number of scans and the sample rate for pre- and post-trigger data, are software programmable prior to the start of a scan sequence.

System Power Connection

The 6220 and other 6000 Series modules offer the flexibility to be powered either directly from a 19V to 30V DC source, or via the included TR-60U AC power adapter.

Ethernet Features

The 6000 Series transfers acquired data to the PC via 10/100BaseT Ethernet, allowing a continuous stream of data to be collected and stored in a PC's memory or hard drive. The most common and highest-performance connection is with dedicated, point-to-point Ethernet link between the PC and the 6220. With an enterprise-wide Ethernet network connection, any number of 6000 Series modules can be connected to the network.

6220 Block Diagram

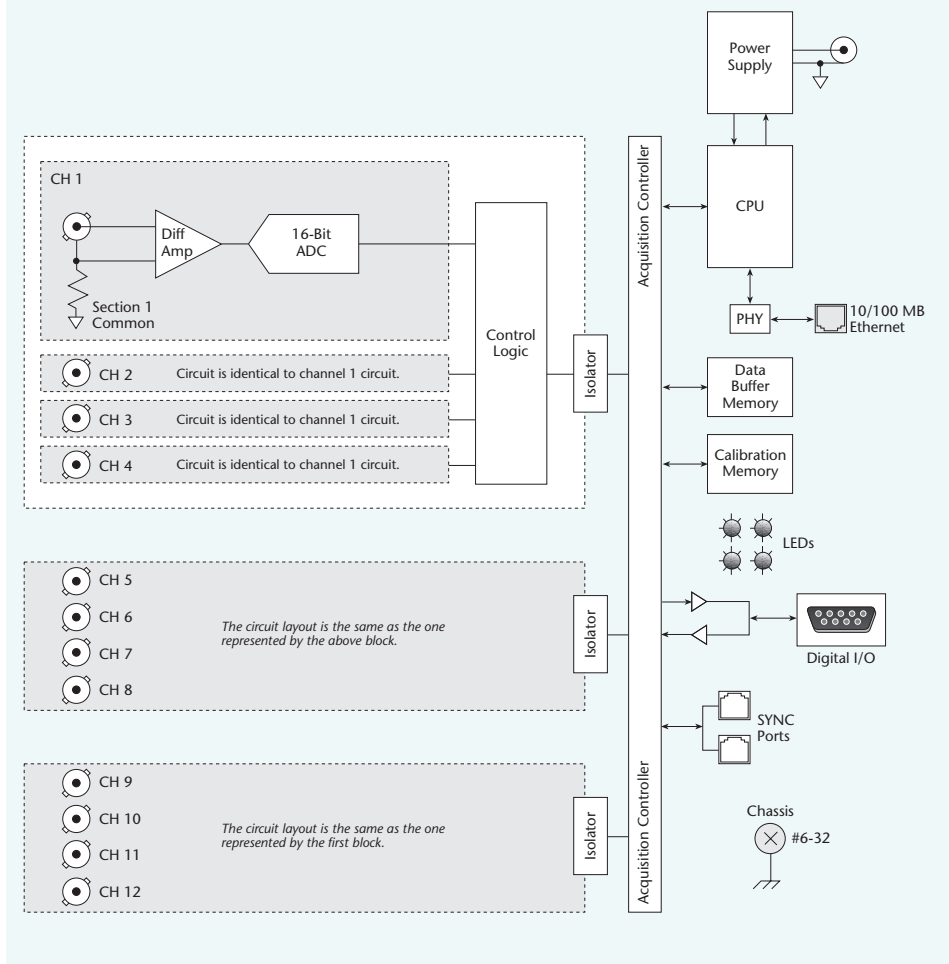

6220

Specifications and Ordering Information

Specifications

The following specifications are typical for the temperature range -40° to 50°C unless otherwise noted.

Input Characteristics

Number of Analog Channels: 12
ADC Resolution: 16 bits
Type of ADC: Successive approximation register (SAR)
Input Range: ±10.0V nominal; overflow will occur if $|V_{in}| \geq (10.2V \text{ to } 10.6V)$
Overvoltage Protection: ±30 V
Conversion Time: 100 kSamples/sec per channel

Accuracy

Measurement Conditions	Percent of Reading (Gain Error)	Offset Error
Calibrated, max (-40° to 50°C)	0.2%	±18.5 mV
Calibrated, typ (25°C, ±5°C)	0.02%	±11.4 mV

Stability

Gain Drift: 10 ppm/°C
Offset Drift: 60 µV/°C
CMRR (fin=60 Hz): -73 dB min
Input Bandwidth (-3 dB): 420 kHz min
Input Impedance
Resistance Between any Two AI-Terminals: 200k Ohm
Input Bias Current: 10 nA
Input Noise
RMS: 1.2 LSB
Peak-to-Peak: 7 LSB
Crosstalk: -80 dB
Settling Time [to 2 LSBs]
10V Step: 25 µs
20V Step: 35 µs
No Missing Codes: 15 bits guaranteed
DNL: ±2 LSB max
INL: ±6 LSB max

Digital I/O Lines

Channels: 8 digital I/O, programmable as a single port, or as individual lines
Power-Up Mode: Inputs pulled low
Connector: DB-9 female
Input Scanning Modes
Asynchronous: Under program control at any time relative to analog scanning
Synchronous: Data captured synchronously with the analog channels
Input Levels
Low: 0 to +0.8V
High: +2.0V to +5.0V
Input Voltage Range without Damage: -0.6V to +5.6V max
Input Pull-Down Resistor: 10k Ohm
Output Voltage Range: 0 to +3V (may be pulled up to +5.6V without damage)
Output Resistance: 40 Ohm
Sampling: 1 MHz max continuous
Output Timing: Outputs are always written asynchronously

Power Consumption

5.5W typ, 6W max
24 VDC @ 0.8A max

Physical Characteristics

Weight: 1.36 Kg (3 lb)
Dimensions: 276.9 mm W x 169.8 mm D x 30.5 mm H (10.9" x 6.685" x 1.2")

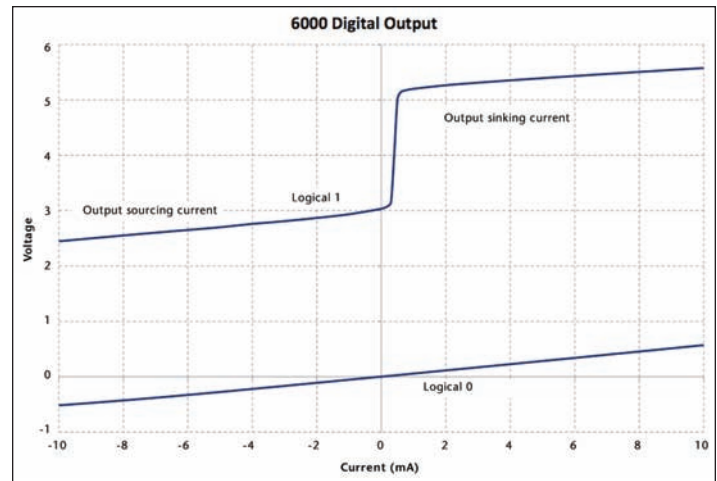

Environmental

The IOtech 6220 is intended for indoor use only but may be used outdoors if installed in a suitable enclosure.

Operating Temperature (IEC 60068-2-1, IEC 60068-2-2): -40° to 50°C
Storage Temperature (IEC 60068-2-1, IEC 60068-2-2): -40° to 75°C
Ingress Protection: IP 40
Operating Humidity (IEC 60068-2-56): 10 to 90% RH, noncondensing
Storage Humidity (IEC 60068-2-56): 5 to 95% RH, noncondensing
Maximum Altitude: 2,000m (6,562 ft.)
Pollution Degree (IEC 60664): 2

Calibration

Calibration Interval: 1 year; contact IOtech for information regarding calibration service.

Ordering Information

Description	Part No.
12-channel, 16-bit resolution, Ethernet-based voltage measurement module, with included <i>Out-of-the-Box</i> Encore software	6220

Accessories & Cables

External power supply, 90 to 264 VAC; requires additional cable,	
CA-1 (US) or CA-216 (European)	TR-60U
Required cable for use with TR-60U; 120V US version	CA-1
Required cable for use with TR-60U; 220V European version	CA-216
RJ12 shielded cable, 6 conductor, SYNC, 0.3m (1 ft.) ¹	CA-74-1
Ethernet crossover cables, 2.133m (7 ft.)	CA-192-7C
Ethernet patch cable, 0.457m (1.5 ft.) ²	CA-242
Ethernet patch cable, 2.133m (7 ft.) ²	CA-242-7
Stacking plate kit	190658A-01
Handle kit	HA-210-5-BK

BUY NOW!

For complete product specifications, pricing, and accessory information, call 1-888-714-3272 (U.S. only) or visit iotech.com/6000series.

- Up to nine units can be synchronized. The total combined length of the SYNC cables is not to exceed 2.438m (8 ft.).
- Ethernet cable length must be <10m (32.8 ft.) in order for the system to be CE Compliant.
- Ethernet crossover cables should only be used for direct network connections. In particular, attempting to connect a device to a Hub using a crossover cable may prevent that network link from functioning. Some modern routers have become an exception by including logic to detect the crossover cable and allow the network link to function.

Features

- Interactive measurement software for *Out-of-the-Box* setup, acquisition, display, logging, analysis, and reporting
- Included with 6000 Series Ethernet-based data acquisition modules
- Advanced feature set with no programming required
- Drag-and-drop functionality
- Easy-to-use set-up wizards
- Ability to drag data directly to Excel®
- Included data analysis tools
- Playback mode
- Sophisticated test report capability
- Incorporate multiple 6000 Series devices into one application
- Supported Operating Systems: Windows 2000®, Windows Vista® x86 (32-bit), and Windows XP® (32-bit)

Overview

Encore is the premier *Out-of-the-Box* data acquisition software package and is included with each 6000 Series module. Encore combines ease of use with advanced functionality, including customizable data layouts, powerful analysis, and reporting capabilities. Instead of having a program to log data, another to analyze, and a third to develop report data, Encore includes the functionality of all three into one package, thus shortening the learning curve, and saving time and cost.

Configuration

Easy-to-use set-up wizards provide rapid hardware configuration. Encore allows you to go from setup to taking measurements in minutes. Users can select one or more available devices from Encore's Hardware Configuration dialog.

Encore allows you to configure the basic acquisition or generation options, such as channel selection, acquisition rate, number of points, and input range. You can also configure start and stop triggers.

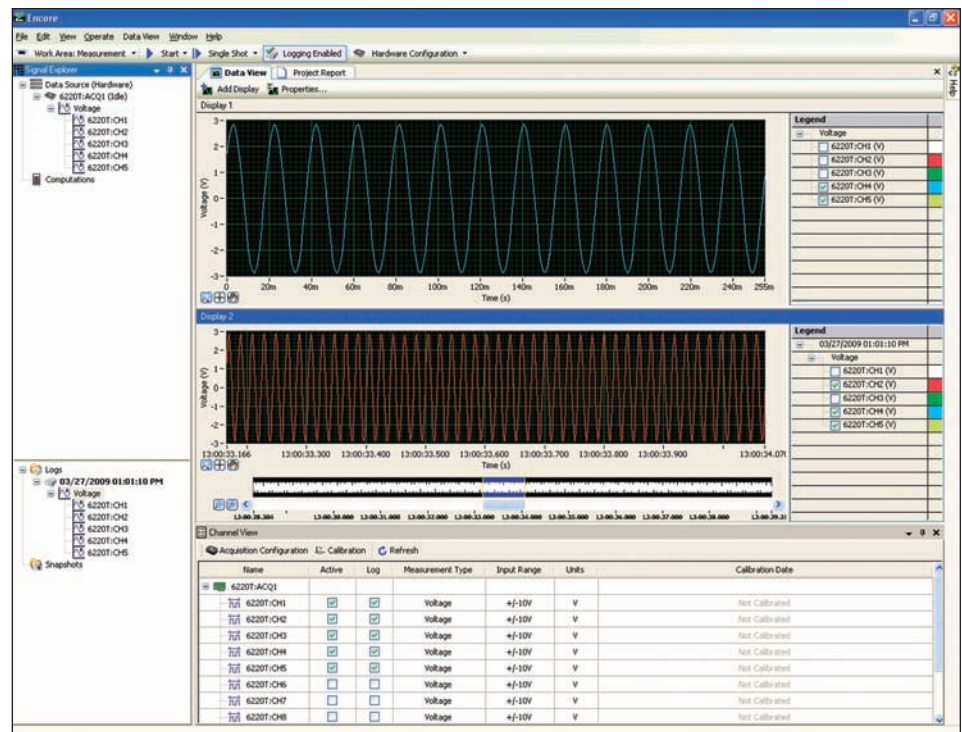

Encore offers an intuitive user interface. Data displays can be configured with multiple charts, overlapping data plots, and user selectable scales.

In addition, within the Channel View table, users can enable (or disable) channels, select measurement type, enable logging, perform mx+b calculation, and more. Channel View configurations can also be shared among multiple projects.

Measurement

Encore allows you to develop data displays quickly with an intuitive, drag-and-drop interface. Encore also offers the ability to easily change plot colors, overlay channels (including previously recorded data), and access multiple devices. Additionally, you can export data to other formats including Excel, ASCII and DIAdem.

Triggering

A variety of programmable analog and digital trigger conditions are available for starting and stopping an acquisition within Encore. Analog triggers include Rising Edge, Falling Edge (with hysteresis), Above Level, Below Level, Inside Window, and Outside Window. Digital triggers include Rising Edge, Falling Edge, Level High, or Level Low. In addition, the Duration trigger may be used to stop an acquisition after a specified time.

Analysis

Included analysis options make Encore IOtech's most advanced *Out-of-the-Box* software package. Features include FFT, power spectrum, statistics, peak value, and RMS calculation. In addition, you can also create custom formulas using Encore's Create Calculated Signal function. Data can also be viewed in the playback work area. Analysis can be computed on live data as well as logged data (post processing).

Analysis options include:

- Statistics: Standard Deviation, Mean, and Variance
- Peak: +Peak, -Peak, and Peak-Peak
- RMS
- DC
- FFT
- Power Spectrum
- Minimum
- Maximum

Export to Excel®

Signals can be exported from Encore to Microsoft Excel. When exporting signals from Encore to Microsoft Excel, the following information is exported:

- Signal name
- Export date and time
- Signal units
- Data values

Reporting

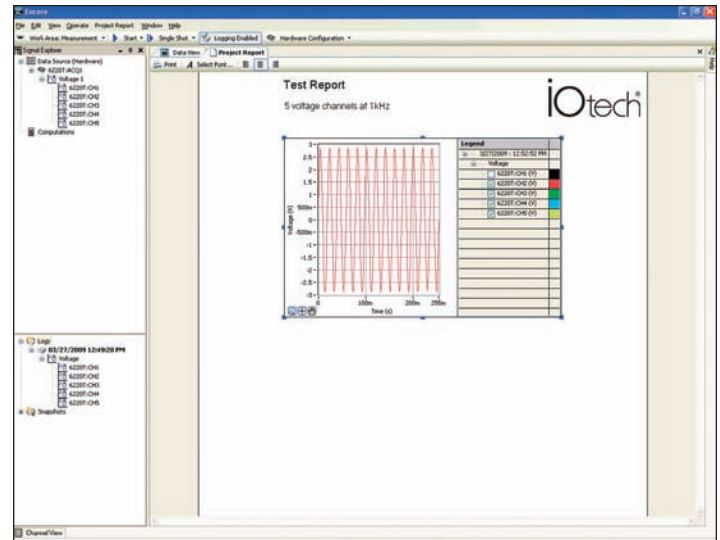

In the Project Report tab you can drag signals from the Signal Explorer, enter text, change fonts, import images, and print or export reports to html

Encore offers sophisticated, built-in test reporting capability which provides the ability to present data in a professional manner. With Encore's test report capability, users can easily develop in-depth test reports.

Within Encore's Project Report tab users can drag signals from the application directly into the report and then enter text, change fonts, import images and print or export reports. Once the report is complete, you even have the ability to acquire new data and easily update any previous report, without re-creating the report. The report can be edited throughout the life of the project.

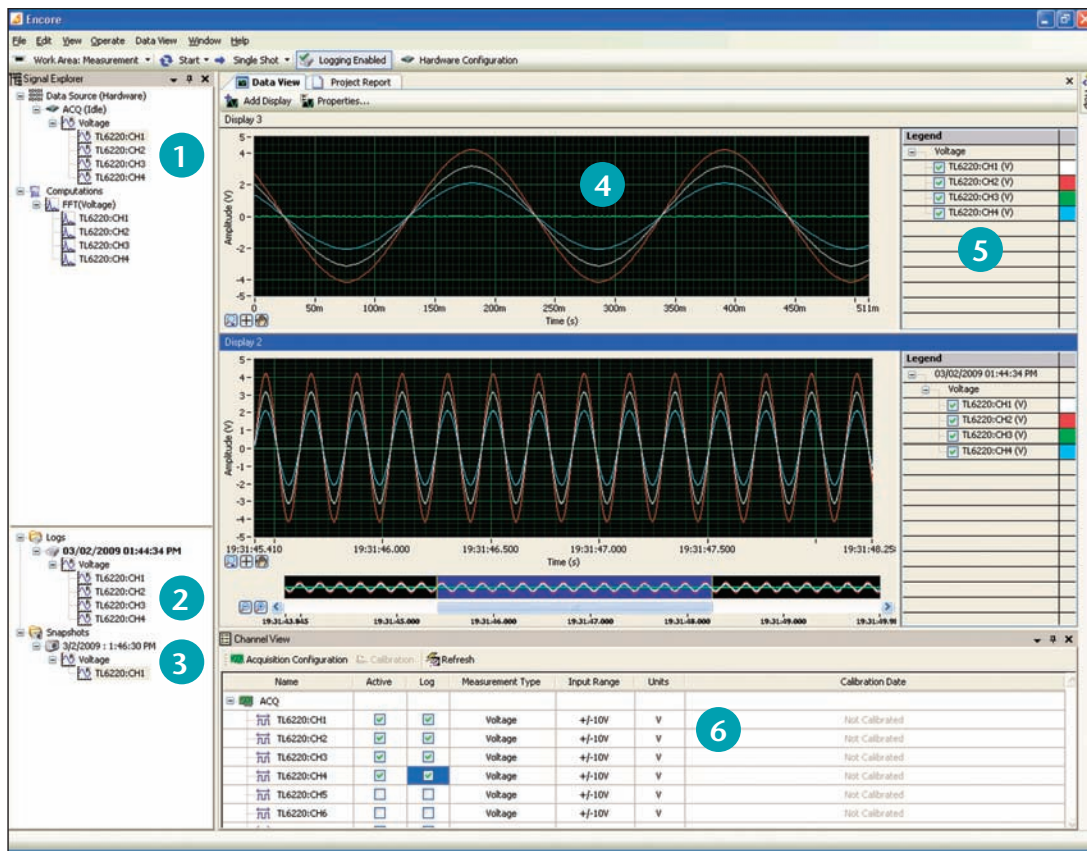

- 1 **Signal Explorer** displays the data sources, computations, snapshots and logs available for your project. It also allows you to select and drag signals into the Data View. Signals can also be dragged directly Into Excel.
- 2 **Log Window** displays a list of a project's logged data [including snapshots] sorted by the time at which you recorded the log or took the snapshot.
- 3 **Snapshots** allow you to save a record of the current values of any signal in your project. You can use snapshots as a reference signal to compare data within the same or another project.
- 4 **Data View** tab allows you to view your data by dragging signals directly from the Signal Explorer or the Log Window. The Data View tab can display signals in several formats, including graphs, charts, and various numeric representations. When you drag a signal to the Data View tab, the signal appears in a new or existing display depending on whether a display showing that type of data already exists.
- 5 **Legend (Graph Legend)** lists every signal displayed in the graph and also shows its corresponding plot color.
- 6 **Channel View** is a table-style section which gives you an overview of all your channels and their settings. You can enable (or disable) channels, select the measurement type, enable (or disable) logging, perform mx+b calculation, and more. You can also use the Channel View toolbar to quickly jump to Acquisition Configuration or [system] Calibration windows.